

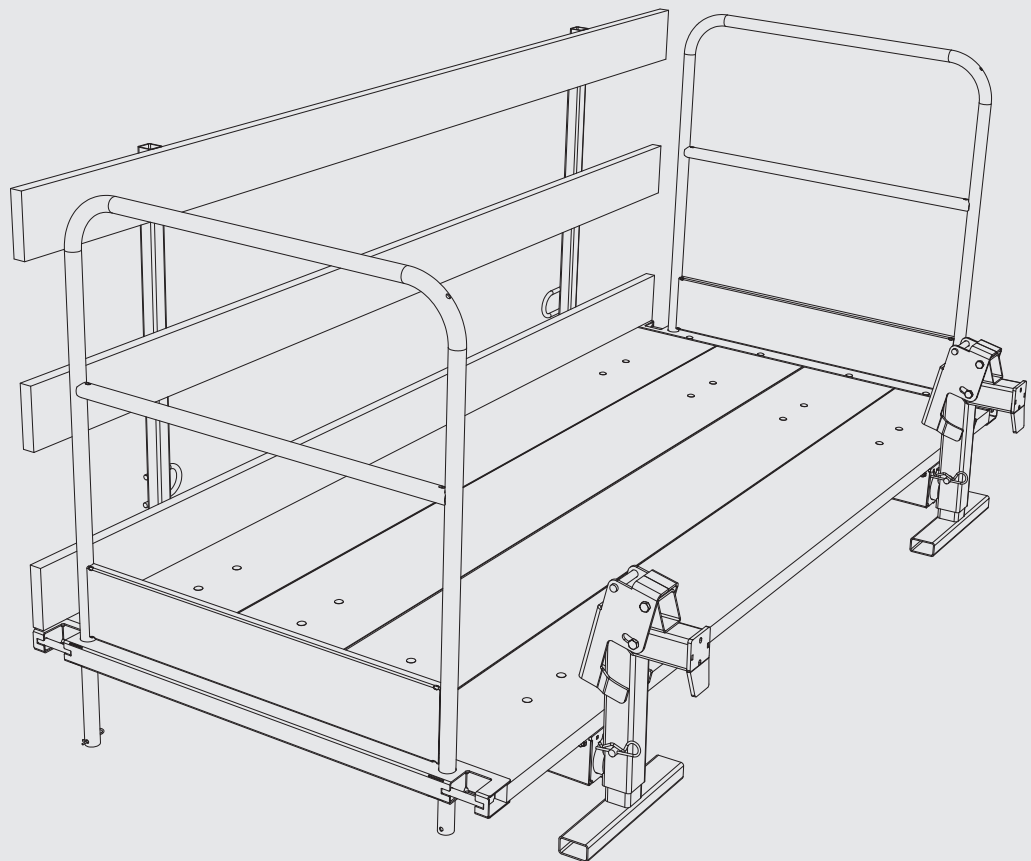

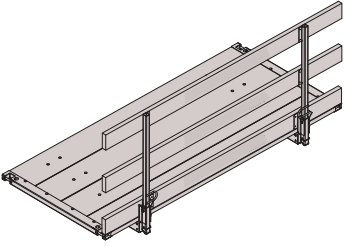

## **Passerella pieghevole di betonaggio BKB 120**

### **Descrizione dei prodotti**

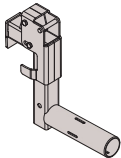
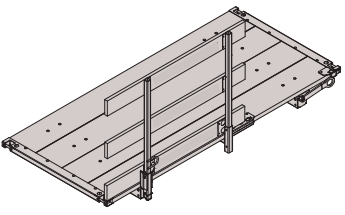
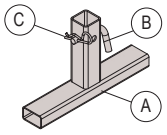
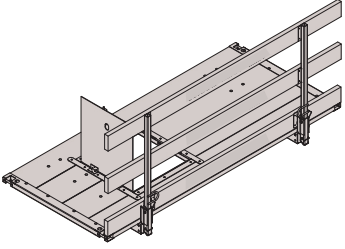
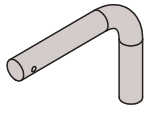

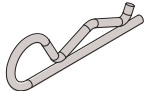
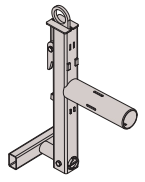
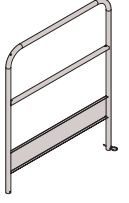
## Descrizione dei prodotti

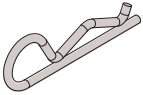
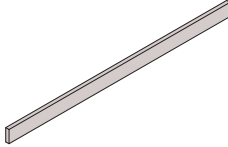
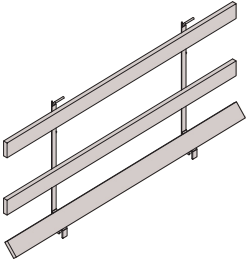
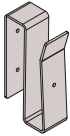
Descrizione	[kg]	Nr. articolo	Descrizione	[kg]	Nr. articolo
BKB 120/270	140,00	<b>181-101.100</b>	BKB testa di sospensione Vinci, zinc.	13,00	<b>181-101.200</b>
					
BKB 120/270 VARIO	134,00	<b>181-101.110</b>	BKB raccordo compl. per testa di sosp. Vinci	3,56	<b>181-101.215</b>
			Compreso nella fornitura: A) BKB raccordo per testa di sosp. Vinci, zinc., 1 pz. 3,30 <b>181-101.210</b> B) Spinotto per basetta d=16 mm, 1 pz. 0,24 <b>181-101.220</b> C) Spina di sicurezza d = 4,0 mm, zinc., 1 pz. 0,02 <b>912-293.100</b>		
BKB 120/270 BOTOLA	156,00	<b>181-101.120</b>			
			Spinotto per basetta d=16 mm	0,24	<b>181-101.220</b>
BKB 120/270 scala telescopica 2,00 - 3,00 m	8,70	<b>181-101.410</b>			
			Spina di sicurezza d = 4,0 mm, zinc.	0,02	<b>912-293.100</b>
					
			BKB testa di sospensione TS12, zinc.	15,00	<b>181-101.300</b>
					
			BKB parapetto, zinc.	10,70	<b>181-101.400</b>
			Compreso nella fornitura: Spina di sicurezza d = 5,0 mm, zinc., 1 pz. 0,02 <b>411-120.110</b>		
					

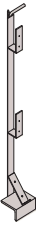
Descrizione	[kg]	Nr. articolo	Descrizione	[kg]	Nr. articolo
Spina di sicurezza d = 5,0 mm, zinc.	0,02	<b>411-120.110</b>	Tavola fermapiede 15 x 3 cm, 1,58 m Tavola fermapiede 15 x 3 cm, 2,68 m	3,60 6,00	<b>181-101.402</b> <b>181-101.404</b>
					
Vinci controparapetto 115/268, zinc.	38,60	<b>131-275.135</b>	Supporto zinc. per tavola fermapiede	0,50	<b>181-101.406</b>
					
Vinci montante parapetto, zinc.	10,80	<b>131-275.136</b>			
					
Vinci mont. di compens. controparapetto, zinc.	11,00	<b>131-275.137</b>			
					
Montante per parapetto di protezione 1,00 m	7,50	<b>211-210.150</b>			
